

CC05-090B Series

Ordering Informations

Model No.	Color	Size	Light Source	Luminous Intensity
CC05WW090B	Warm White (3,000-3,500K)	890x16x13.5mm	18W	1600-1700Lm
CC05NW090B	Natural White(4,000-4,500K)	890x16x13.5mm	18W	1700-1800Lm
CC05WE090B	Cool White (6,000-6,500K)	890x16x13.5mm	18W	1700-1800Lm

Outline Drawing

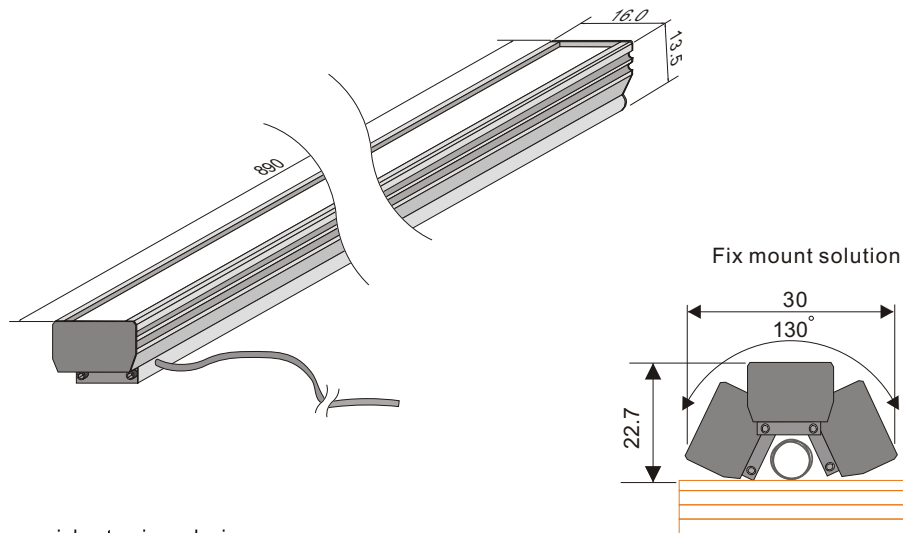

Features

- Aluminum casing with special extrusions design
- Energy saving
- Eco-friendly product
- Long life time (up to 50,000hours)
- High luminance
- Low power consumption
- RoHS compliant
- Low surface heat against hand touch
- No UV or IR damage light sensitive items

* The dimensional outline drawings are common in (CC05WW090B & CC05NW090B & CC05WE090B)

Unit: mm

Specifications

Parameter	Rating value
Light source	SMD
Input Voltage	DC 24V
Installation Diameter	N/A
Operating Temperature	-40 to +70 °C
Beam Angle (Adjustable tilt)	090°
Weight	800g
CRI	70-80

Warning:

- * Do not look permanently to the light sources.
- * Specified performance measured in DC 24V.

