

DL09AK Series

Ordering Informations

Model No.	Color	Size	Light Source	Luminous Intensity
DL09AKWW7W	Warm White (3,000-3,500K)	∅13x41mm	7W	500-600Lm
DL09AKNW7W	Natural white (4,000-4,500K)	∅13x41mm	7W	550-650Lm
DL09AKWE7W	Cool White (6,000-6,500K)	∅13x41mm	7W	550-650Lm

Outline Drawing

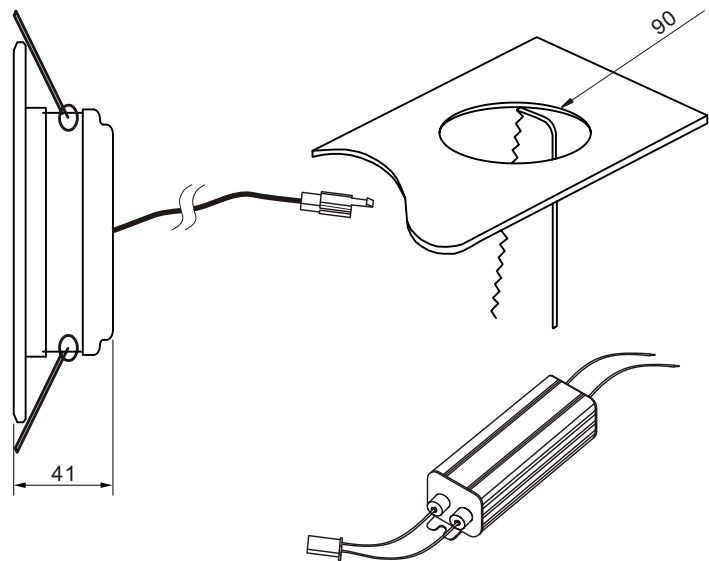
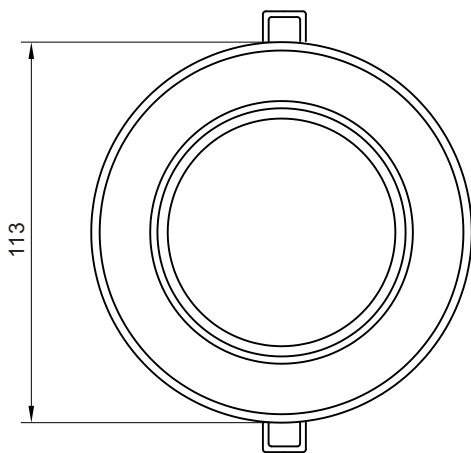

Features

- Aluminum casing with special extrusions design
- Energy saving
- Eco-friendly product
- Long life time (up to 50,000hours)
- High luminance
- Low power consumption
- RoHS compliant
- Low surface heat against hand touch
- No UV or IR damage light sensitive items
- POWER FACTOR ≥ 0.92

* The dimensional outline drawings are common in (DL09AKWW7W & DL09AKNW7W & DL09AKWE7W)

Unit: mm

Specifications

Parameter	Rating value
Size	N/A
Light source	SMD
Input Voltage	AC90-260V , 50/60Hz
Installation Diameter	90
Operating Temperature	-40 to +70 °C
Beam Angle (Adjustable tilt)	150°
Weight	400g
CRI	75-83

Warning:

- * Do not look permanently to the light sources.
- * Specified performance measured in AC90-260V 50/60Hz

