

DL15AK Series

Ordering Informations

Model No.	Color	Size	Light Source	Luminous Intensity
DL15AKWW15W	Warm White (3,000-3,500K)	∅180x50mm	15W	1300-1400Lm
DL15AKNW15W	Natural white (4,000-4,500K)	∅180x50mm	15W	1350-1450Lm
DL15AKWE15W	Cool White (6,000-6,500K)	∅180x50mm	15W	1350-1450Lm

Outline Drawing

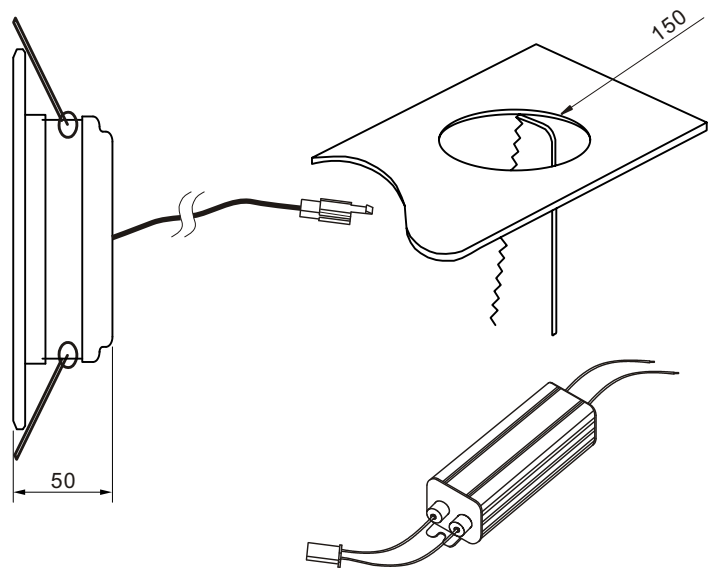
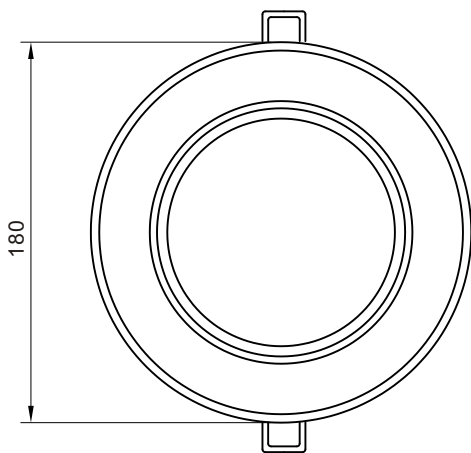

Features

- Aluminum casing with special extrusions design
- Energy saving
- Eco-friendly product
- Long life time (up to 50,000hours)
- High luminance
- Low power consumption
- RoHS compliant
- Low surface heat against hand touch
- No UV or IR damage light sensitive items
- POWER FACTOR ≥ 0.92

* The dimensional outline drawings are common in (DL15AKWW15W & DL15AKNW15W & DL15AKWE15W)

Unit: mm

Specifications

Parameter	Rating value
Size	N/A
Light source	SMD
Input Voltage	AC90-260V , 50/60Hz
Installation Diameter	150
Operating Temperature	-40 to +70 °C
Beam Angle (Adjustable tilt)	150°
Weight	700g
CRI	75-83

Warning:

- * Do not look permanently to the light sources.
- * Specified performance measured in AC90-260V 50/60Hz

