

DL3F Series

Ordering Informations

Model no.	Color	Size	Light Source	Luminous Intensity
DL3FWW3W(W)	Warm White (3000-3500K)	Ø90x47mm	3x1W	230-270lm
DL3FNW3W(W)	Natural White (4000-4500K)	Ø90x47mm	3x1W	270-290lm
DL3FWE3W(W)	Cool White (6000-6500K)	Ø90x47mm	3x1W	290-310lm

Outline Drawing



DL3F Series

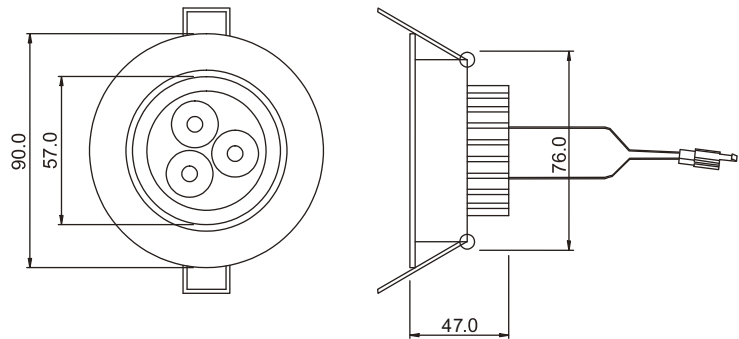

Features

- Aluminum casing with special extrusions design
- Energy saving
- Eco-friendly product
- Long life time (up to 50,000hours)
- High luminance
- Low power consumption
- RoHS compliant
- Low surface heat against hand touch
- No UV or IR damage light sensitive items

* The dimensional outline drawings are common in DL3FWW3W(W), DL3FNW3W(W) and DL3FWE3W(W) Unit: mm

Specifications

Parameter	Rating value
Light source	SMD 3W
Input Voltage	AC85-260V , 50/60Hz
Installation Diameter	Ø76
Operating Temperature	-40 to +70 °C
Beam Angle (Adjustable tilt)	30°(15°)
Weight	285g
CRI	70-80
Body / Finish Color	White

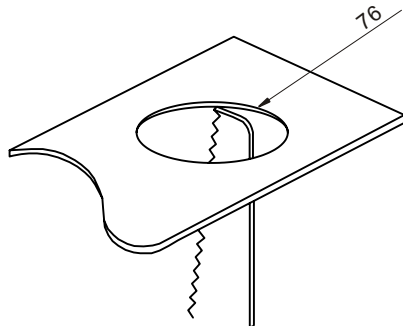

Warning

- * Do not look permanently to the light sources
- * Specified performance measured in AC 85-260V

