

DL7M Series

Ordering Informations

Model No.	Color	Size	Light Source	Luminous Intensity
DL7MWW7W	Warm White (3,000-3,500K)	Ø104x58.5mm	7x1W	550-600lm
DL7MWE7W	Cool White (6,000-6,500K)	Ø104x58.5mm	7x1W	600-650lm

Outline Drawing



DL7M Series

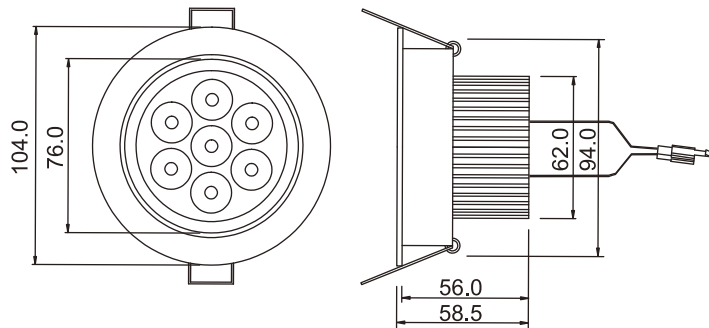

Features

- Aluminum casing with special extrusions design
- Energy saving
- Eco-friendly product
- Long life time
- High luminance
- Low power consumption
- RoHS compliant
- Low surface heat against hand touch
- No UV or IR damage light sensitive items
- Highly efficient heat release mechanism

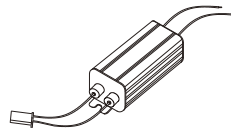

AC 85-220V, 50/60Hz
Supply unit

* The dimensional outline drawings are common in (DL7MWW7W and DL7MWE7W)

Unit: mm

Specifications

Parameter	Rating value
Power Consumption	7W
Input Voltage	AC 85-220V, 50/60Hz
Installation Diameter	94.0mm
Light Source	7x1W power LED
Operating Temperature	- 40 to +70°C
Beam Angle (Adjustable tilt)	45°(15°)
Weight	427g
CRI	85
Body / Finish Color	Die-cast Aluminium casing

Warning:

- * Do not look permanently to the light sources.
- * Specified performance measured in 85-220Vac.

