

E27-5CH Series

Ordering Informations

Model no.	Color	Size	Light Source	Luminous Intensity
E27-5CHWW5W	Warm White (3,000-3,500K)	ø60x112mm	5W	400-450Lm
E27-5CHNW5W	Natural white (4,000-4,500K)	ø60x112mm	5W	450-500Lm
E27-5CHWE5W	Cool White (6,000-6,500K)	ø60x112mm	5W	450-500Lm

Outline Drawing

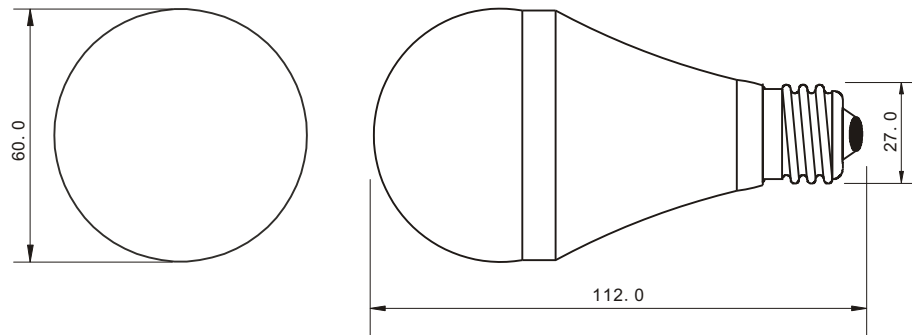

Features

- Aluminum casing with special extrusions design
- Energy saving
- Eco-friendly product
- Long life time (up to 50,000hours)
- High luminance
- Low power consumption
- RoHS compliant
- Low surface heat against hand touch
- No UV or IR damage light sensitive items

* The dimensional outline drawings are common in (E27-5CHWW5W & (E27-5CHNW5W & (E27-5CHWE5W) Unit: mm

Specifications

Parameter	Rating value
Light source	SMD 5W
Input Voltage	AC90-260V 50/60Hz
Installation Diameter	N/A
Operating Temperature	-40 to +70°C
Beam Angle	150°
Weight	145g
CRI	70-80

Warning:

- * Do not look permanently to the light sources.
- * Specified performance measured in AC90-260V 50/60Hz

