

HB030A Series

Ordering Informations

Model no.	Color	Size	Light Source	Luminous Intensity
HB030AWW01	Warm White (3,000-3,500K)	Ø415 x 512mm	30W	2500-3000Lm
HB030ANW01	Neutral White (4,500-4,750K)	Ø415 x 512mm	30W	3000-3500Lm
HB030AWE01	Cool White (5,500-6,500K)	Ø415 x 512mm	30W	3000-3500Lm



HB030A Series

Outline Drawing

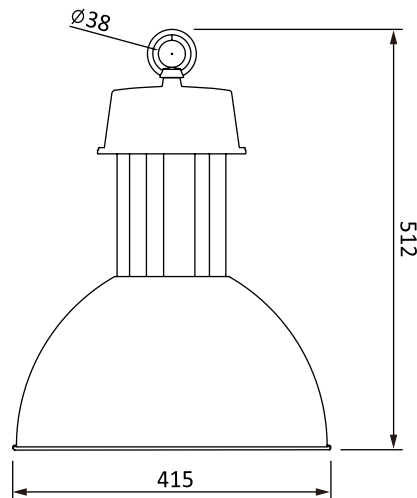

* The dimensional outline drawings are common in (HB030AWW01, HB030ANW01 and HB030AWE01)

Unit: mm

Features

- Aluminum casing with special extrusions design
- Energy saving
- Eco-friendly product
- Long life time
- High luminance
- Low power consumption
- High efficient heat release mechanism
- Low surface heat against hand touch
- No UV or IR damage light sensitive items

Specifications

Parameter	Rating value
Power Consumption	30W
Input Voltage	AC 110-260V, 50/60Hz
Light Source	30W power LED
Operating Temperature	-40 to +70°C
Beam Angle	45°
CRI	85
Weight	4kg
Body / Finish Color	Aluminium

Warning:

- * Do not look permanently to the light sources
- * Specified performance measured in AC 110-260V

