

# HB050A Series

## Ordering Informations

Model no.	Color	Size	Light Source	Luminous Intensity
HB050AWW01	Warm White (3,000-3,500K)	Ø415 x 512mm	50W	4500-5000Lm
HB050ANW01	Neutral White (4,500-4,750K)	Ø415 x 512mm	50W	5000-5500Lm
HB050AWE01	Cool White (5,500-6,500K)	Ø415 x 512mm	50W	5000-5500Lm



HB050A Series

## Outline Drawing

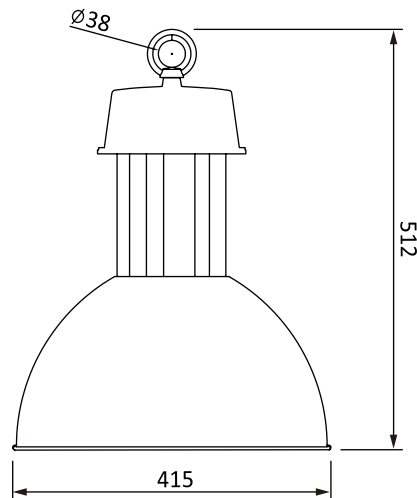

\* The dimensional outline drawings are common in (HB050AWW01, HB050ANW01 and HB050AWE01)

Unit: mm

## Features

- Aluminum casing with special extrusions design
- Energy saving
- Eco-friendly product
- Long life time
- High luminance
- Low power consumption
- High efficient heat release mechanism
- Low surface heat against hand touch
- No UV or IR damage light sensitive items

## Specifications

Parameter	Rating value
Power Consumption	50W
Input Voltage	AC 110-260V, 50/60Hz
Light Source	50W power LED
Operating Temperature	-40 to +70°C
Beam Angle	45°
CRI	85
Weight	5.5kg
Body / Finish Color	Aluminium

### Warning:

- \* Do not look permanently to the light sources
- \* Specified performance measured in AC 110-260V

